



**Technical and Test Institute
for Construction Prague**

Prosecká 811/76a
190 00 Prague
Czech Republic
eota@tzus.cz



Member of



www.eota.eu

European Technical Assessment

**ETA 17/0363
of 25/04/2017**

(English language translation, the original version is in Czech language)

Technical Assessment Body issuing the ETA: Technical and Test Institute
for Construction Prague

Trade name of the construction product

SMART S-RPE

**Product family to which the construction
product belongs**

Product area code: 33
Bonded injection type anchor for use
in non-cracked concrete

Manufacturer

pgb-Polska Sp. z o.o.,
ul. Fryderyka Wilhelma Redena 3
41-807 Zabrze
Polska

Manufacturing plant

pgb-Polska Sp. z o.o.
Plant 1

**This European Technical Assessment
contains**

13 pages including 10 Annexes which form
an integral part of this assessment

**This European Technical Assessment is
issued in accordance with regulation
(EU) No 305/2011, on the basis of**

ETAG 001-Part 1 and Part 5, edition 2013,
used as European Assessment Document
(EAD)

Translations of this European Technical Assessment in other languages shall fully correspond to the original issued document and should be identified as such.

Communication of this European Technical Assessment, including transmission by electronic means, shall be in full (excepted the confidential Annex(es) referred to above). However, partial reproduction may be made, with the written consent of the issuing Technical Assessment Body - Technical and Test Institute for Construction Prague. Any partial reproduction has to be identified as such

1. Technical description of the product

The SMART S-RPE with steel elements is bonded anchor (injection type).

Steel elements can be galvanized or stainless steel.

Steel element is placed into a drilled hole filled with injection mortar. The steel element is anchored via the bond between metal part, injection mortar and concrete. The anchor is intended to be used with embedment depth from 8 diameters to 12 diameters.

The illustration and the description of the product are given in Annex A.

2. Specification of the intended use in accordance with the applicable EAD

The performances given in Section 3 are only valid if the anchor is used in compliance with the specifications and conditions given in Annex B.

The provisions made in this European Technical Assessment are based on an assumed working life of the anchor of 50 years. The indications given on the working life cannot be interpreted as a guarantee given by the producer, but are to be regarded only as a means for choosing the products in relation to the expected economically reasonable working life of the works.

3. Performance of the product and references to the methods used for its assessment

3.1 Mechanical resistance and stability (BWR 1)

Essential characteristic	Performance
Characteristic resistance for tension loads	See Annex C 1
Characteristic resistance for shear loads	See Annex C 2
Displacement	See Annex C 3

3.2 Safety in case of fire (BWR 2)

Essential characteristic	Performance
Reaction to fire	Anchorage satisfy requirements for Class A1
Resistance to fire	No performance assessed

3.3 Hygiene, health and environment (BWR 3)

Regarding dangerous substances contained in this European Technical Assessment, there may be requirements applicable to the products falling within its scope (e.g. transposed European legislation and national laws, regulations and administrative provisions). In order to meet the provisions of the Regulation (EU) No 305/2011, these requirements need also to be complied with, when and where they apply.

3.4 Safety in use (BWR 4)

For basic requirement safety in use the same criteria are valid as for Basic Requirement Mechanical resistance and stability.

3.5 Sustainable use of natural resources (BWR 7)

For the sustainable use of natural resources no performance was determined for this product.

3.6 General aspects relating to fitness for use

Durability and serviceability are only ensured if the specifications of intended use according to Annex B 1 are kept.

4. **Assessment and verification of constancy of performance (AVCP) system applied with reference to its legal base**

According to the Decision 96/582/EC of the European Commission¹ the system of assessment verification of constancy of performance (see Annex V to Regulation (EU) No 305/2011) given in the following table apply.

Product	Intended use	Level or class	System
Metal anchors for use in concrete	For fixing and/or supporting to concrete, structural elements (which contributes to the stability of the works) or heavy units.	-	1

5. **Technical details necessary for the implementation of the AVCP system, as provided in the applicable EAD**

5.1 **Tasks of the manufacturer**

The manufacturer may only use raw materials stated in the technical documentation of this European Technical Assessment.

The factory production control shall be in accordance with the control plan which is a part of the technical documentation of this European Technical Assessment. The control plan is laid down in the context of the factory production control system operated by the manufacturer and deposited at Technický a zkušební ústav stavební Praha, s.p.² The results of factory production control shall be recorded and evaluated in accordance with the provisions of the control plan.

5.2 **Tasks of the notified bodies**

The notified body shall retain the essential points of its actions referred to above and state the results obtained and conclusions drawn in a written report.

The notified certification body involved by the manufacturer shall issue a certificate of constancy of performance of the product stating the conformity with the provisions of this European Technical Assessment.

In cases where the provisions of the European Technical Assessment and its control plan are no longer fulfilled the notified body shall withdraw the certificate of constancy of performance and inform Technický a zkušební ústav stavební Praha, s.p without delay.

Issued in Prague on 25.04.2017

By

Ing. Mária Schaan

Head of the Technical Assessment Body

¹ Official Journal of the European Communities L 254 of 08.10.1996

² The control plan is a confidential part of the documentation of the European Technical Assessment, but not published together with the ETA and only handed over to the approved body involved in the procedure of AVCP.

Threaded rod

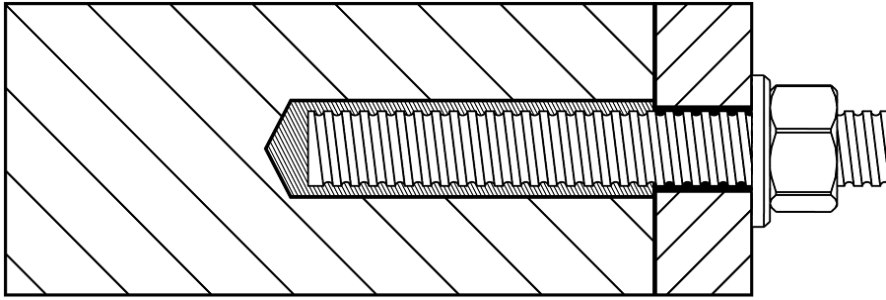

SMART S-RPE

Product description
Installed conditions

Annex A 1

Coaxial cartridge

SMART S-RPE

150 ml

380 ml

400 ml

410 ml

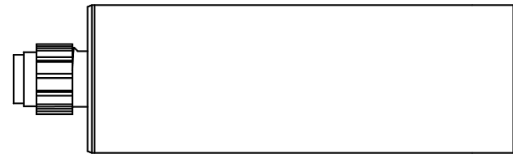
**Side by side cartridge**

SMART S-RPE

350 ml

825 ml

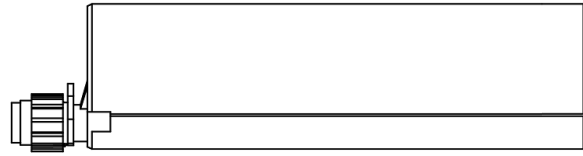
**Two part foil in a single piston component cartridge**

SMART S-RPE

150 ml

170 ml

300 ml

550 ml

850 ml

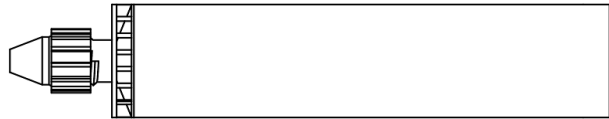
**Peeler cartridge**

SMART S-RPE

280 ml

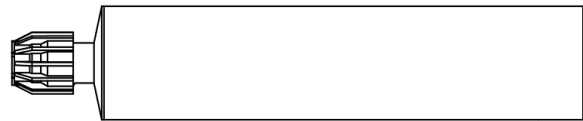
**Marking of the mortar cartridges**

Identifying mark of the producer, Trade name, Charge code number, Storage life, Curing and processing time

Mixing nozzle

SMCH4-01

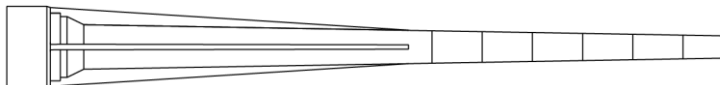

SMCH4-10

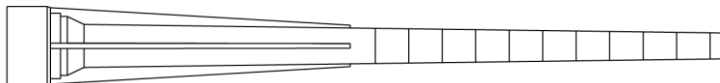

SMCH4-11

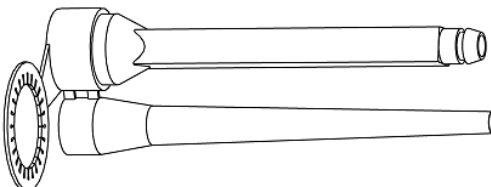

SMCH4-12

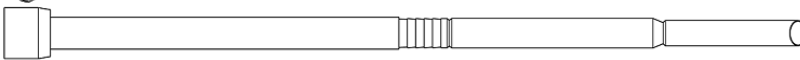

SMCH4-06 for 850

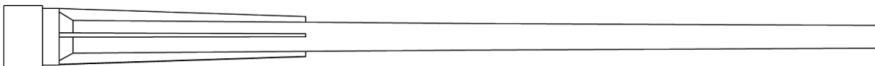
**SMART S-RPE****Product description**

Injection system

Annex A 2

Threaded rod M8, M10, M12, M16, M20, M24

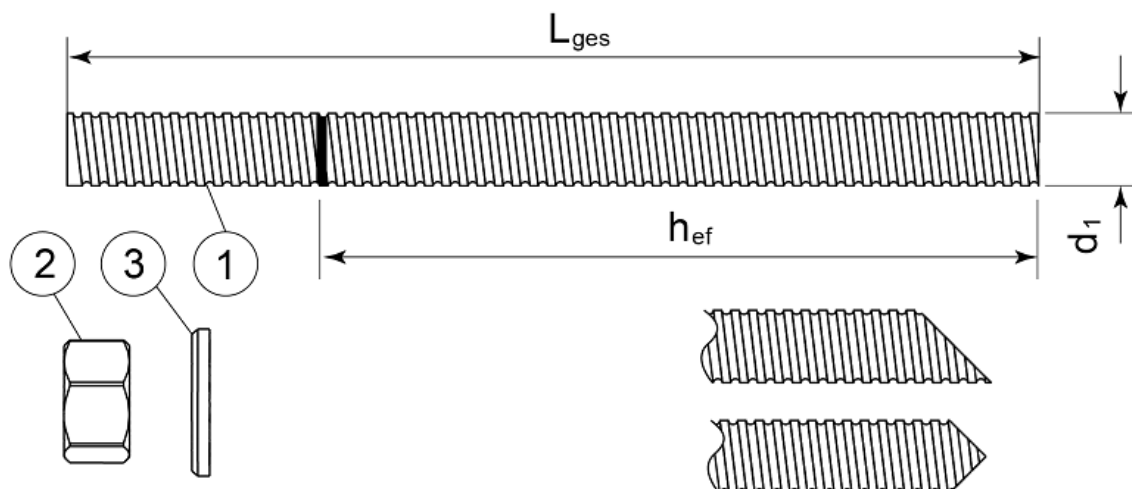

Standard commercial threaded rod with marked embedment depth

Part	Designation	Material
Steel, zinc plated $\geq 5 \mu\text{m}$ acc. to EN ISO 4042 or Steel, Hot-dip galvanized $\geq 40 \mu\text{m}$ acc. to EN ISO 1461 and EN ISO 10684 or Steel, zinc diffusion coating $\geq 15 \mu\text{m}$ acc. to EN 13811		
1	Anchor rod	Steel, EN 10087 or EN 10263 Property class 4.6, 5.8, 8.8, 10.9* EN ISO 898-1
2	Hexagon nut EN ISO 4032	According to threaded rod, EN 20898-2
3	Washer EN ISO 887, EN ISO 7089, EN ISO 7093 or EN ISO 7094	According to threaded rod
Stainless steel		
1	Anchor rod	Material: A2-70, A4-70, A4-80, EN ISO 3506
2	Hexagon nut EN ISO 4032	According to threaded rod
3	Washer EN ISO 887, EN ISO 7089, EN ISO 7093 or EN ISO 7094	According to threaded rod
High corrosion resistant steel		
1	Anchor rod	Material: 1.4529, 1.4565, EN 10088-1
2	Hexagon nut EN ISO 4032	According to threaded rod
3	Washer EN ISO 887, EN ISO 7089, EN ISO 7093 or EN ISO 7094	According to threaded rod

*Galvanized rod of high strength are sensitive to hydrogen induced brittle failure

SMART S-RPE

Product description

Threaded rod and materials

Annex A 3

Specifications of intended use

Anchorage subject to:

- Static and quasi-static load.

Base materials

- Non-cracked concrete.
- Reinforced or unreinforced normal weight concrete of strength class C20/25 at minimum and C50/60 at maximum according EN 206-1:2000-12.

Temperature range:

- -40°C to +80°C (max. short. term temperature +80°C and max. long term temperature +50°C)

Use conditions (Environmental conditions)

- Structures subject to dry internal conditions (zinc coated steel, stainless steel, high corrosion resistance steel).
- Structures subject to external atmospheric exposure including industrial and marine environment, if no particular aggressive conditions exist (stainless steel A4, high corrosion resistance steel).
- Structures subject to permanently damp internal condition, if no particular aggressive conditions exist (stainless steel A4, high corrosion resistance steel).
- Structures subject to permanently damp internal condition, with particular aggressive conditions exist (high corrosion resistance steel).

Note: Particular aggressive conditions are e.g. permanent, alternating immersion in seawater or the splash zone of seawater, chloride atmosphere of indoor swimming pools or atmosphere with extreme chemical pollution (e.g. in desulphurization plants or road tunnels where de-icing materials are used).

Use categories:

- Category 2 – installation in dry, wet concrete or flooded hole.

Design:

- The anchorages are designed in accordance with the EOTA Technical Report TR 029 “Design of bonded anchors” under the responsibility of an engineer experienced in anchorages and concrete work.
- Verifiable calculation notes and drawings are prepared taking account of the loads to be anchored. The position of the anchor is indicated on the design drawings.

Installation:

- Dry or wet concrete or flooded hole.
- Hole drilling by hammer drill mode.
- Anchor installation carried out by appropriately qualified personnel and under the supervision of the person responsible for technical matters of the site.

SMART S-RPE

**Intended use
Specifications**

Annex B 1

Applicator gun

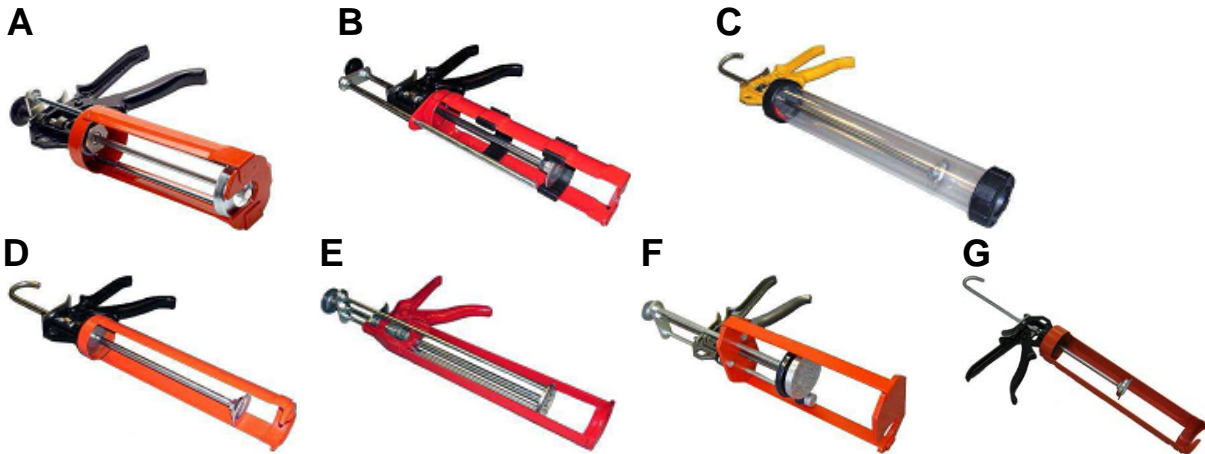

Applicator gun	A	B	C	D	E	F	G
Cartridge	Coaxial 380ml 400ml 410ml	Side by side 350ml	Foil capsule 150ml 300ml 550ml	Foil capsule 150ml 300ml Peeler 280ml	Coaxial 150ml	Side by side 825ml	Foil capsule 850ml

Cleaning brush type SMCH3

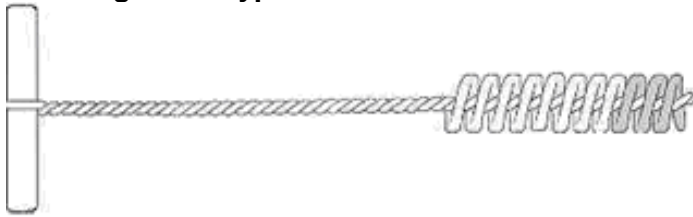

Blow pump type SMCH2

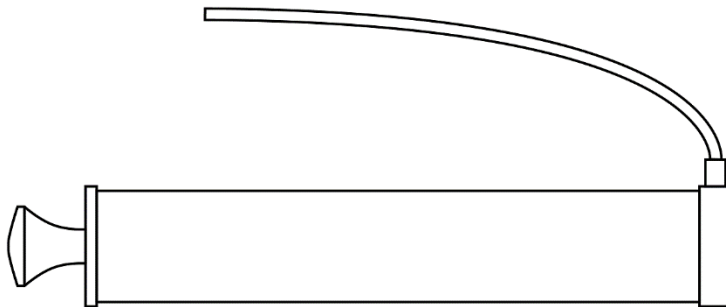

SMART S-RPE

Intended use
Applicator guns
Cleaning brush

Annex B 2

Installation procedure

1. Drill the hole to the correct diameter and depth. This can be done with either a rotary percussion or rotary hammer drilling machine depending upon the substrate. 

2. Thoroughly clean the hole in the following sequence using the SMART brush with the required extensions and the SMART blow pump.

Blow Clean x2.
Brush Clean x2.
Blow Clean x2.
Brush Clean x2.
Blow Clean x2.



If the hole collects water after the initial cleaning this water must be removed before injecting the resin.

3. Select the appropriate static mixer nozzle for the installation, open the cartridge/foil and screw onto the mouth of the cartridge. Insert the cartridge into the correct applicator gun.
4. Extrude the first part of the cartridge to waste until an even colour has been achieved without streaking in the resin.



5. If necessary, cut the extension tube to the depth of the hole and push onto the end of the mixer nozzle, and (for threaded bar 16mm dia. or more) fit the correct resin stopper to the other end. Attach extension tubing and resin stopper.

6. Insert the mixer nozzle (resin stopper / extension tube if applicable) to the bottom of the hole. Begin

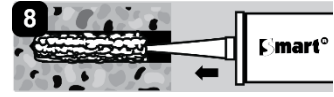

to extrude the resin and slowly withdraw the mixer nozzle from the hole ensuring that there are no air voids as the mixer nozzle is withdrawn. Fill the hole to approximately $\frac{1}{2}$ to $\frac{3}{4}$ full and remove the mixer nozzle completely.

7. Insert the clean threaded bar, free from oil or other release agents, to the bottom of the hole using a back and forth twisting motion ensuring all the threads are thoroughly coated. Adjust to the correct position within the stated working time.

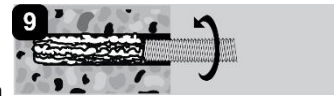

8. Any excess resin should be expelled from the hole evenly around the steel element showing that the hole is full. This excess resin should be removed from around the mouth of the hole before it sets.

9. Leave the anchor to cure. Do not disturb the anchor until the appropriate loading/curing time has elapsed depending on the substrate conditions and ambient temperature.

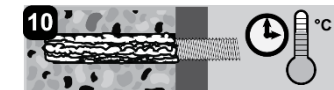

- 10 Attach the fixture and tighten the nut to the recommended torque.

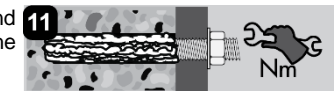

Do not overtighten.

SMART S-RPE

Intended use
 Installation procedure

Annex B 3

Table B1: Installation parameter

Size			M8	M10	M12	M16	M20	M24
Nominal drill hole diameter	$\varnothing d_0$	[mm]	10	12	14	18	22	26
Diameter of cleaning brush	d_b	[mm]	14	14	20	20	29	29
Torque moment	T_{inst}	[Nm]	10	20	40	80	120	160
$h_{ef} = 8d$								
Embedment depth	h_{ef}	[mm]	64	80	96	128	160	192
Depth of drill hole	h_0	[mm]	$h_{ef}+5$	$h_{ef}+5$	$h_{ef}+5$	$h_{ef}+5$	$h_{ef}+5$	$h_{ef}+5$
Minimum edge distance	c_{min}	[mm]	40	40	40	60	80	95
Minimum spacing	s_{min}	[mm]	40	40	40	60	80	95
Minimum thickness of member	h_{min}	[mm]	$h_{ef} + 30 \text{ mm} \geq 100 \text{ mm}$			$h_{ef} + 2d_0$		
$h_{ef} = 12d$								
Embedment depth	h_{ef}	[mm]	96	120	144	192	240	288
Depth of drill hole	h_0	[mm]	$h_{ef}+5$	$h_{ef}+5$	$h_{ef}+5$	$h_{ef}+5$	$h_{ef}+5$	$h_{ef}+5$
Minimum edge distance	c_{min}	[mm]	50	60	70	95	120	145
Minimum spacing	s_{min}	[mm]	50	60	70	95	120	145
Minimum thickness of member	h_{min}	[mm]	$h_{ef} + 30 \text{ mm} \geq 100 \text{ mm}$			$h_{ef} + 2d_0$		

Table B2: Cleaning

All diameters
- 2 x blowing
- 2 x brushing
- 2 x blowing
- 2 x brushing
- 2 x blowing

Table B3: Minimum curing time

Cartridge temperature [°C]	T Work [mins]	Base material Temperature [°C]	T Load [mins]
+5 to +10	12	+5 to +10	120
+10 to +20	6	+10 to +20	80
+20 to +25	4	+20 to +25	40
+25 to +30	3	+25 to +30	30
+30 to +35	2	+30 to +35	20
+35 to +40	1,5	+35 to +40	15
+40		+40	10

T Work is typical gel time at highest base material temperature in the range.

T Load is minimum set time required until load can be applied at the lowest base material temperature in the range.

SMART S-RPE

Intended use
Installation parameters
Curing time

Annex B 4

Table C1: Design method TR 029
Characteristic values of resistance to tension load

Steel failure – Characteristic resistance									
Size			M8	M10	M12	M16	M20	M24	
Steel grade 4.6	$N_{Rk,s}$	[kN]	15	23	34	63	98	141	
Partial safety factor	$\gamma_{Ms}^{1)}$	[-]	2,0						
Steel grade 5.8	$N_{Rk,s}$	[kN]	18	29	42	79	123	177	
Partial safety factor	$\gamma_{Ms}^{1)}$	[-]	1,5						
Steel grade 8.8	$N_{Rk,s}$	[kN]	29	46	67	126	196	282	
Partial safety factor	$\gamma_{Ms}^{1)}$	[-]	1,5						
Steel grade 10.9	$N_{Rk,s}$	[kN]	37	58	84	157	245	353	
Partial safety factor	$\gamma_{Ms}^{1)}$	[-]	1,4						
Stainless steel grade A2-70, A4-70	$N_{Rk,s}$	[kN]	26	41	59	110	172	247	
Partial safety factor	$\gamma_{Ms}^{1)}$	[-]	1,9						
Stainless steel grade A4-80	$N_{Rk,s}$	[kN]	29	46	67	126	196	282	
Partial safety factor	$\gamma_{Ms}^{1)}$	[-]	1,6						
Stainless steel grade 1.4529	$N_{Rk,s}$	[kN]	26	41	59	110	172	247	
Partial safety factor	$\gamma_{Ms}^{1)}$	[-]	1,5						
Stainless steel grade 1.4565	$N_{Rk,s}$	[kN]	26	41	59	110	172	247	
Partial safety factor	$\gamma_{Ms}^{1)}$	[-]	1,9						

Pullout in non-cracked concrete C20/25									
Size			M8	M10	M12	M16	M20	M24	
Characteristic bond resistance in non-cracked concrete									
Temperature range: -40°C to +80°C	τ_{Rk}	[N/mm ²]	6	6	5	5	4	4	
Dry/wet concrete and flooded hole									
Partial safety factor	$\gamma_{Mc}^{1)}$	[-]	1,8 ²⁾						
Factor for concrete	C25/30	ψ_c	[-]	1,04					
	C30/37			1,08					
	C35/45			1,12					
	C40/50			1,15					
	C45/55			1,17					
	C50/60			1,19					

Splitting failure									
Size			M8	M10	M12	M16	M20	M24	
Edge distance	$c_{cr,sp}$	[mm]	$2 \cdot h_{ef}$						
Spacing	$s_{cr,sp}$	[mm]	$2 \cdot c_{cr,sp}$						
Partial safety factor	$\gamma_{Msp}^{1)}$	[-]	1,8						

¹⁾ In absence of national regulations

²⁾ The partial safety factor $\gamma_2=1,2$ is included

SMART S-RPE	Annex C 1
Performances Characteristic resistance for tension loads	

Table C2: Design method TR 029
Characteristic values of resistance to shear load

Steel failure without lever arm			M8	M10	M12	M16	M20	M24
Size								
Steel grade 4.6	$V_{Rk,s}$	[kN]	7	12	17	31	49	71
Partial safety factor	$\gamma_{Ms}^{1)}$	[-]	1,67					
Steel grade 5.8	$V_{Rk,s}$	[kN]	9	15	21	39	61	88
Partial safety factor	$\gamma_{Ms}^{1)}$	[-]	1,25					
Steel grade 8.8	$V_{Rk,s}$	[kN]	15	23	34	63	98	141
Partial safety factor	$\gamma_{Ms}^{1)}$	[-]	1,25					
Steel grade 10.9	$V_{Rk,s}$	[kN]	18	29	42	79	123	177
Partial safety factor	$\gamma_{Ms}^{1)}$	[-]	1,5					
Stainless steel grade A2-70, A4-70	$V_{Rk,s}$	[kN]	13	20	30	55	86	124
Partial safety factor	$\gamma_{Ms}^{1)}$	[-]	1,56					
Stainless steel grade A4-80	$V_{Rk,s}$	[kN]	15	23	34	63	98	141
Partial safety factor	$\gamma_{Ms}^{1)}$	[-]	1,33					
Stainless steel grade 1.4529	$V_{Rk,s}$	[kN]	13	20	30	55	86	124
Partial safety factor	$\gamma_{Ms}^{1)}$	[-]	1,25					
Stainless steel grade 1.4565	$V_{Rk,s}$	[kN]	13	20	30	55	86	124
Partial safety factor	$\gamma_{Ms}^{1)}$	[-]	1,56					
Steel failure with lever arm			M8	M10	M12	M16	M20	M24
Size								
Steel grade 4.6	$M^o_{Rk,s}$	[N.m]	15	30	52	133	260	449
Partial safety factor	$\gamma_{Ms}^{1)}$	[-]	1,67					
Steel grade 5.8	$M^o_{Rk,s}$	[N.m]	19	37	66	166	325	561
Partial safety factor	$\gamma_{Ms}^{1)}$	[-]	1,25					
Steel grade 8.8	$M^o_{Rk,s}$	[N.m]	30	60	105	266	519	898
Partial safety factor	$\gamma_{Ms}^{1)}$	[-]	1,25					
Steel grade 10.9	$M^o_{Rk,s}$	[N.m]	37	75	131	333	649	1123
Partial safety factor	$\gamma_{Ms}^{1)}$	[-]	1,50					
Stainless steel grade A2-70, A4-70	$M^o_{Rk,s}$	[N.m]	26	52	92	233	454	786
Partial safety factor	$\gamma_{Ms}^{1)}$	[-]	1,56					
Stainless steel grade A4-80	$M^o_{Rk,s}$	[N.m]	30	60	105	266	519	898
Partial safety factor	$\gamma_{Ms}^{1)}$	[-]	1,33					
Stainless steel grade 1.4529	$M^o_{Rk,s}$	[N.m]	26	52	92	233	454	786
Partial safety factor	$\gamma_{Ms}^{1)}$	[-]	1,25					
Stainless steel grade 1.4565	$M^o_{Rk,s}$	[N.m]	26	52	92	233	454	786
Partial safety factor	$\gamma_{Ms}^{1)}$	[-]	1,56					
Concrete pryout failure								
Factor <i>k</i> from TR 029			2					
Design of bonded anchors, Part 5.2.3.3			2					
Partial safety factor	$\gamma_{Mp}^{1)}$	[-]	1,5					
Concrete edge failure								
See section 5.2.3.4 of Technical Report TR 029 for the Design of Bonded Anchors								
Partial safety factor	$\gamma_{Mc}^{1)}$	[-]	1,5					

¹⁾ In absence of national regulations

SMART S-RPE

Performances

Characteristic resistance for shear loads

Annex C 2

Table C3: Displacement under tension and shear load

Size		M8	M10	M12	M16	M20	M24
Tension load							
F	[kN]	6,3	9,9	15,9	23,8	29,8	37,7
δ_{N0}	[mm]	0,2	0,3	0,4	0,4	0,4	0,6
$\delta_{N\infty}$	[mm]	0,83	0,83	0,83	0,83	0,83	0,83
Shear load							
F	[kN]	3,5	5,5	8,0	15,0	23,3	33,6
δ_{V0}	[mm]	2,5	2,5	2,5	2,5	2,5	2,5
$\delta_{V\infty}$	[mm]	3,7	3,7	3,7	3,7	3,7	3,7

SMART S-RPEPerformances
Displacement**Annex C 3**